

PL-66 Square ADA Privacy Installation Diagram

(Minimum Door Thickness 1-3/8")

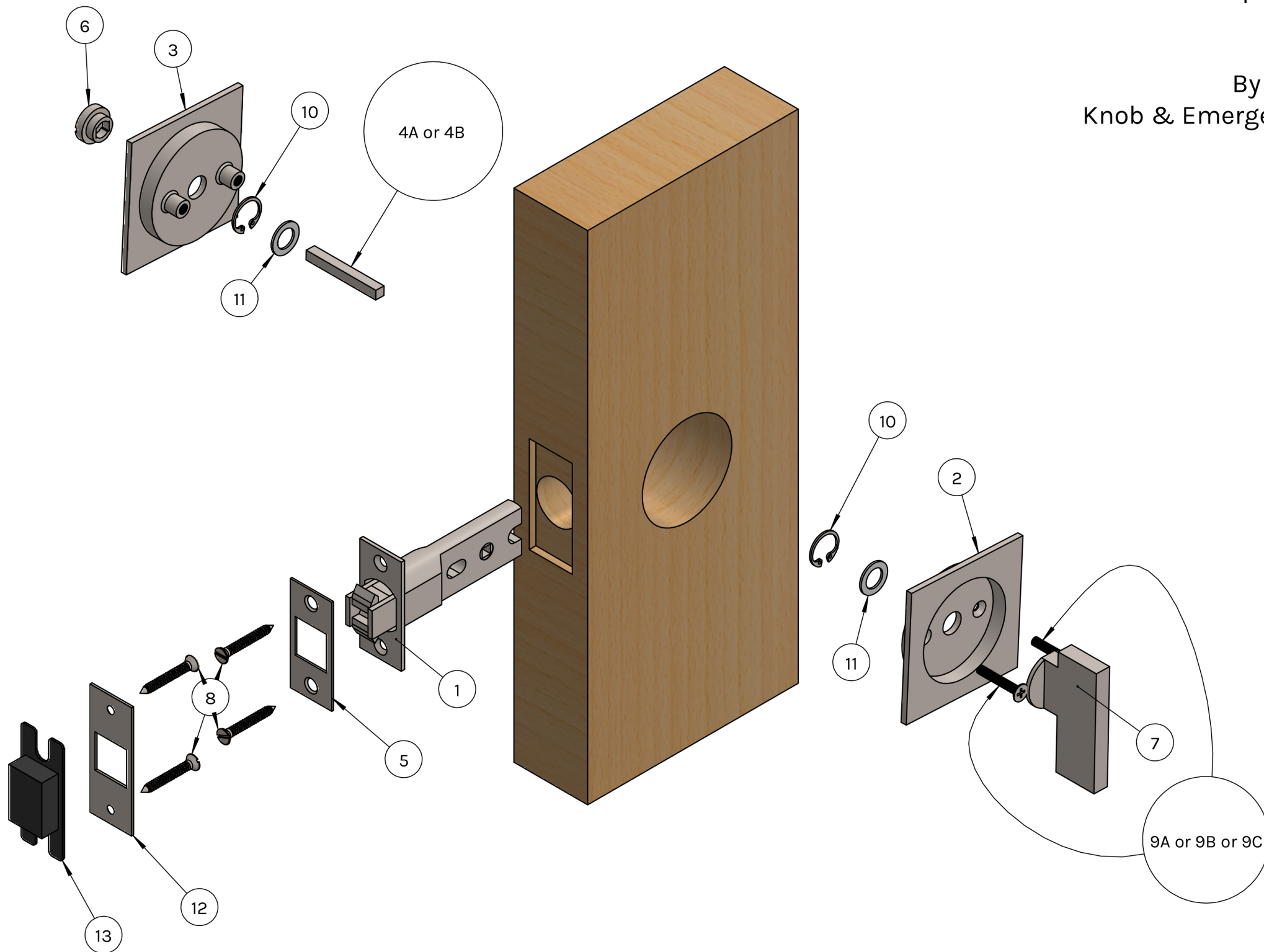

*Note: Turnpiece/ Emergency Release come pre-installed on Interior and Exterior Plate

By design, ADA Compliant Oversized Knob & Emergency Release will not allow door to retract fully into door pocket.

A track stop is recommended.



linnea.

linnea-home.com
(800) 219-2366

Component List

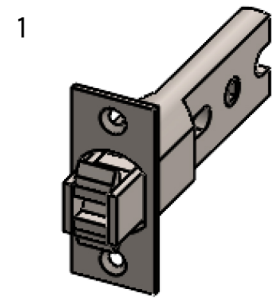

Latch
PL-LAT66B-USS
(Needs 1)

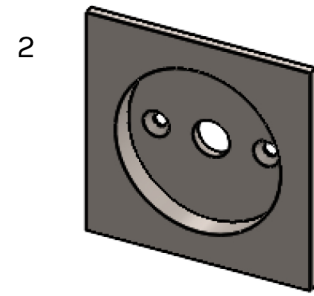

Inside Trim
PLA66S-I
(Needs 1)

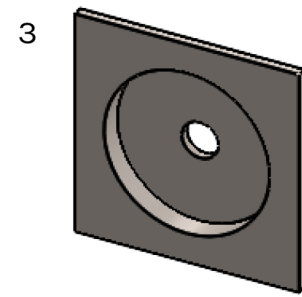

Outside Trim
PLA66S-O
(Needs 1)

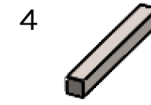

Spindle
4A: PL-SPDL31
4B: PL-SPDL36

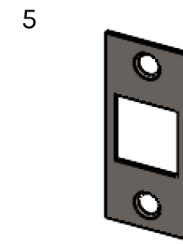

Face Plate
PL-LAT66FP
(Needs 1)

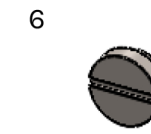

Emergency Release
PL-KNER
(Needs 1)

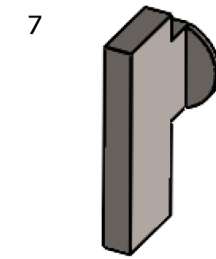

ADA Turnpiece
PL-KNADA
(Needs 1)



Wood Screw
#8 X 3/4"
(Needs 4)

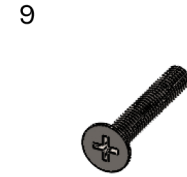

Machine Screw
9A: SCR-M4FL20
9B: SCR-M4FL23
9C: SCR-M4FL28



Snap Ring
PL-CCLIP11
(Needs 2)

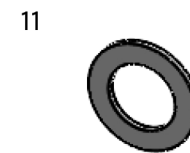

Plastic Washer
PL-WAS12
(Needs 2)



Strike Plate
PL-LAT66STK
(Needs 1)

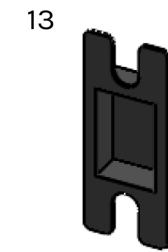

Dust Box
(Needs 1)