

SECTION A-A

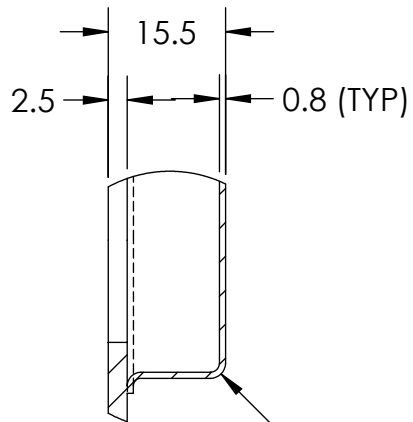

DETAIL B

RPO-150

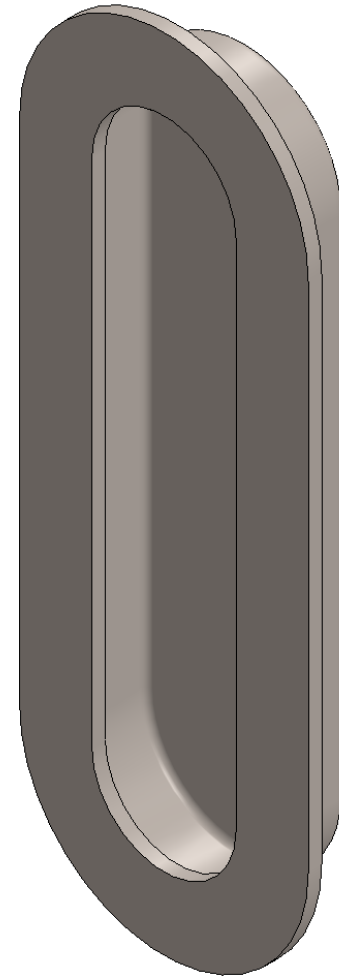