

SECTION A-A

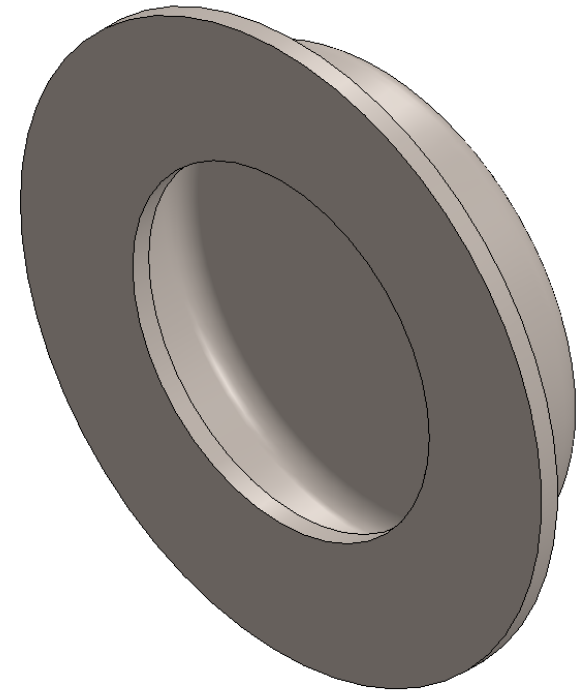

RPR-65

